

Eurolumen • Light Fixture Specifications Table

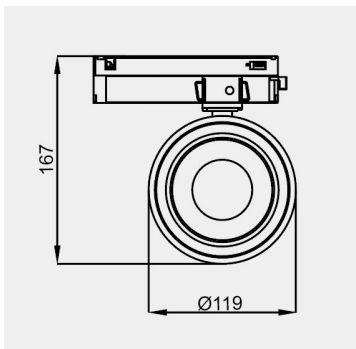

ELX425

TECHNICAL DATA

Wattage: 30W 35W

SDCM: ≤ 5

Color Temperature (CCT): 2700K/3000K/3500K/4000K

CRI: 90

Beam Angle: 15° 24° 36° 55°

Voltage: 220V

Dimming Support: DALI Bluetooth 0-10V ON/OFF

Useful Life: 50,000h

Warranty: 5 Years

PERFORMANCE



Image may not match reference. EUROLUMEN reserves the right to amend any of the product's components. The data related to flux, power and colour temperature maybe subject to changes made by the manufacturer.