

Eurolumen • Light Fixture Specifications Table

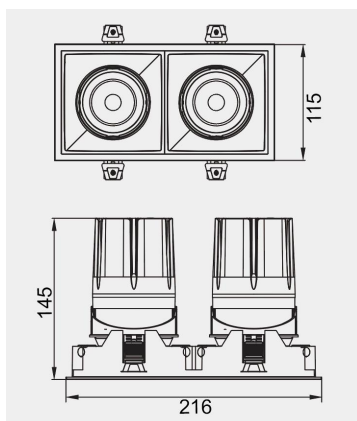

ELX344

TECHNICAL DATA

Wattage: 30W 40W 50W

SDCM: ≤ 5

Color Temperature (CCT): 2700K/3000K/3500K/4000K

CRI: 90

Beam Angle: Adjustable 15°~35°

Voltage: 220V

Dimming Support: DALI Bluetooth 0-10V ON/OFF

Useful Life: 50,000h

Warranty: 5 Years

PERFORMANCE



Image may not match reference. EUROLUMEN reserves the right to amend any of the product's components. The data related to flux, power and colour temperature maybe subject to changes made by the manufacturer.